



***“Starting Point”***

**ETHOS™**



# ETHOS Opis

- Ekran 4.7"
- Intuicyjny system obsługi
- Wskaźnik zasilania
- Wymienna czołowa pokrywa
- Grafika do 4 parametrów
- Kompatybilny z CAN – nie ma potrzeby używania adapterów CAN
- Całkowite pokrycie EOBD
- Szybka identyfikacja pojazdu
- Przywołanie ostatnich 20 pojazdów
- Zapisywanie i przechowywanie danych na karcie CF
- Programowalny przycisk „S”
- Bezpośrednie drukowanie przez złącze USB



# Dwie Konfiguracje

- **Standard –**
  - Funkcja EOBD z oprogramowaniem i adapterem
    - 9 trybów EOBD dla samochodów od 2001r.
- **Deluxe –**
- **Funkcja modelu Standard +**
  - Wszystkie marki europejskie (pliki **VAT files**)
  - Wszystkie modele azjatyckie (na rynek europejski)
    - Rozbudowany system odczytu i kasowania kodów błędów
    - Odczyt parametrów bieżących
    - Kasowanie kontrolki serwisu
    - Komplet adapterów i kluczy w zestawie



# DeLuxe kit

Standard to DeLuxe  
Upgrade kit

Standard kit





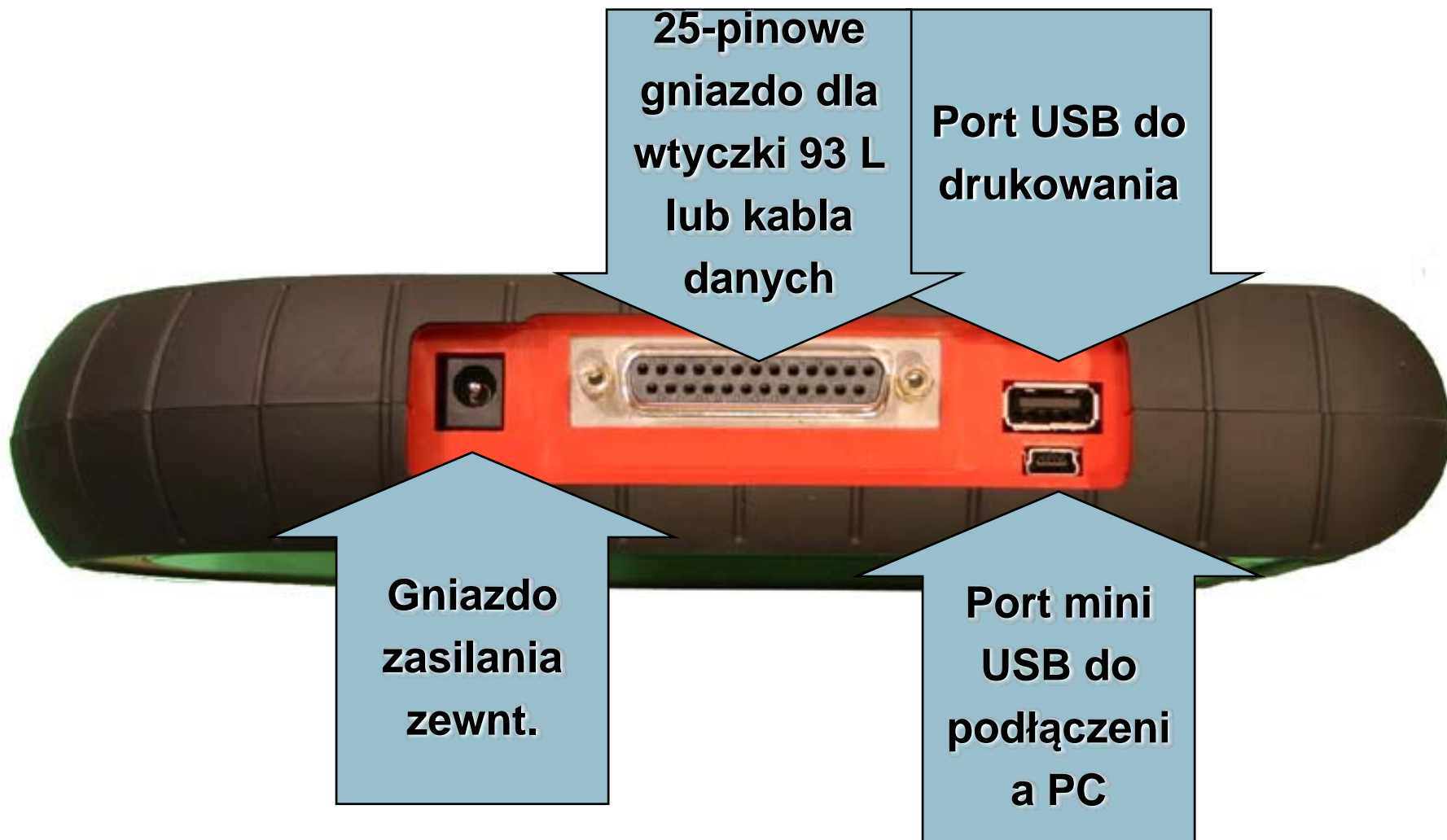

**25-pinowe  
gniazdo dla  
wtyczki 93 L  
lub kabla  
danych**

**Port USB do  
drukowania**

**Gniazdo  
zasilania  
zewnt.**

**Port mini  
USB do  
podłączeni  
a PC**



**Gniazdo karty  
pamięci  
CompactFlash**

**ETHOS™**



**Last Vehicle**

**Previous Vehicles and Data**



**Przejdź do  
ostatniego  
pojazdu**

**Vehicles**

**S**

**ETHOS™**



Last Vehicle

**Previous Vehicles and Data**

Global OP

US Don

Asian V

Tools

**Przywołaj  
ostatnie 20  
pojazdów i  
zapisane  
dane**

## Previous Vehicles

 Last 20  Resto

1998 CHEVROLET MP

1996 CHEVROLET MP

1998 LINCOLN CAR 4.6

1999 TOYOTA COROLLA 1.8L L4 MFI...

1998 CHEVROLET MONTE CARLO 3.8L ...



1998 CHEVROLET MONTE CARLO 3.8L...





2001 LINCOLN CAR 4.6L V8 SOHC E...

1998 CHEVROLET MALIBU 3.1L V6 C... ▼

**Szybki przywołanie  
ostatnich 20  
pojazdów**

**Restore** 

 Last 20  Restore  Delete

	12:14:2006 07:06	3	
	2004 HYUNDAI SANTA FE 2.7L V6 ...		
	12:14:2006 07:10	4	
	2004 HYUNDAI SANTA FE 2.7L V6 ...		
	12:14:2006 14:33	5	
	2003 FORD CAR FOCUS		
	01:04:2007 14:24		
	2001 LEXUS LS 430		

**Odtwórz do 50  
zapisanych danych  
lub 50 zapisanych  
ekranów**

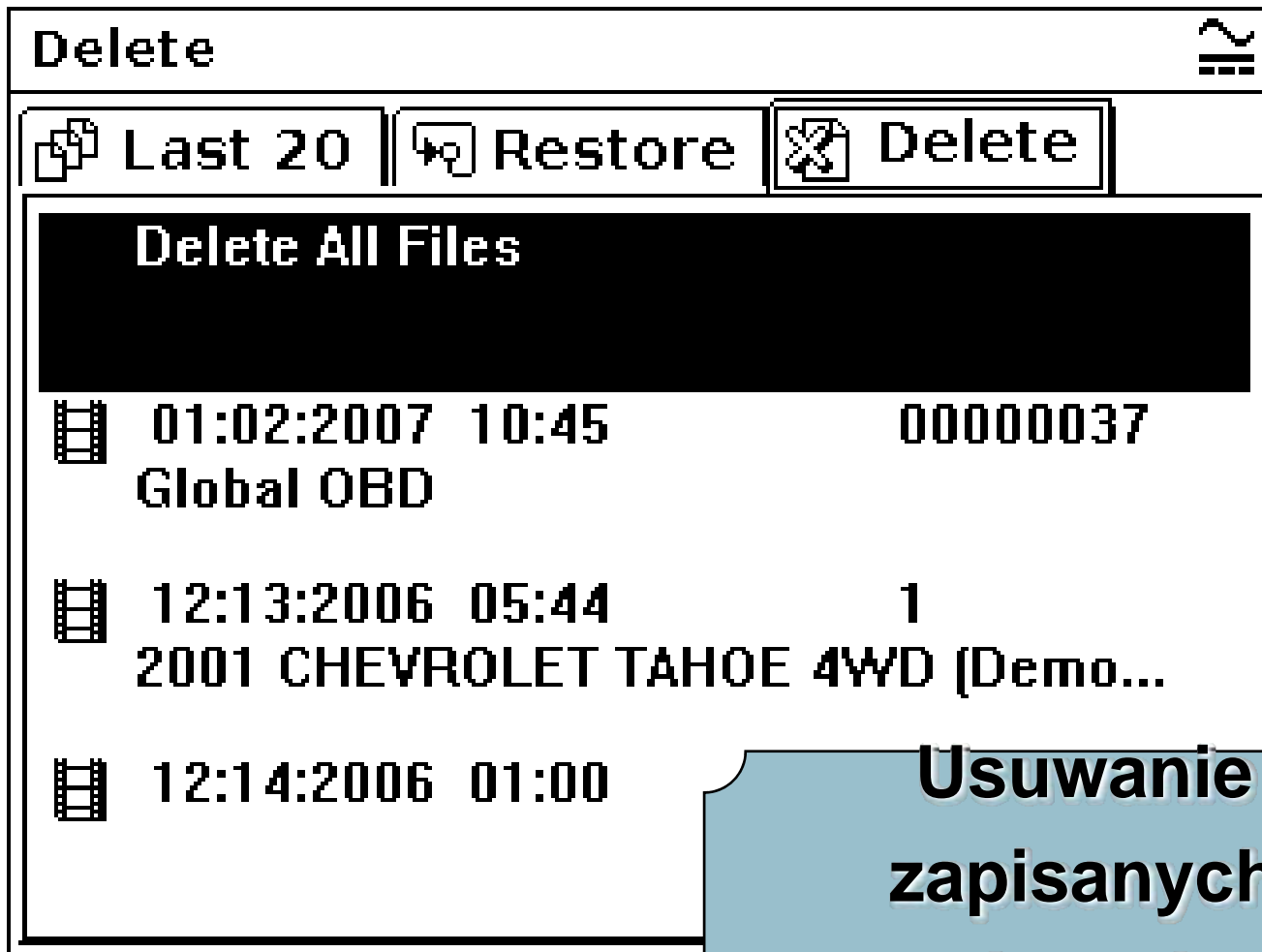

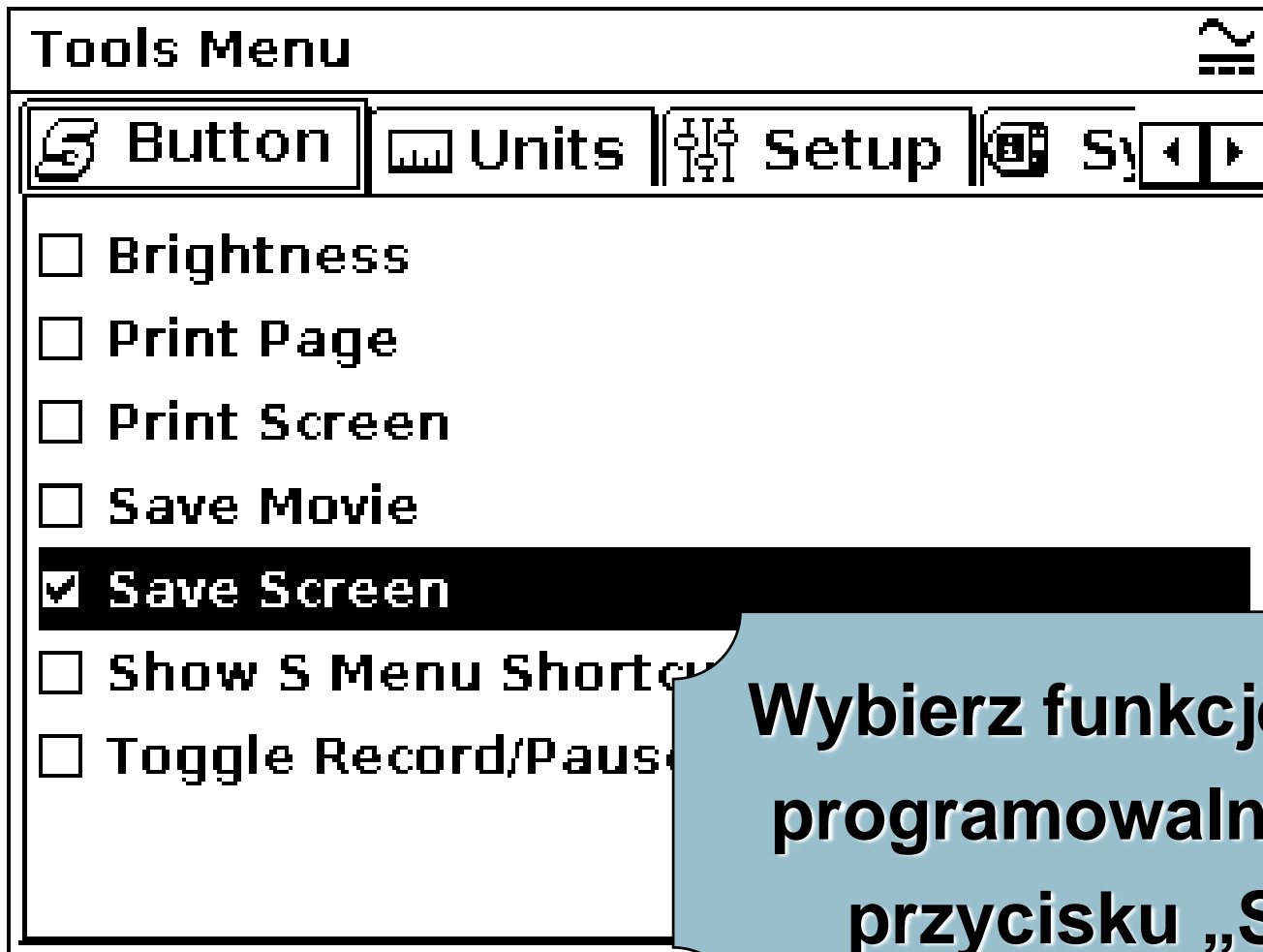



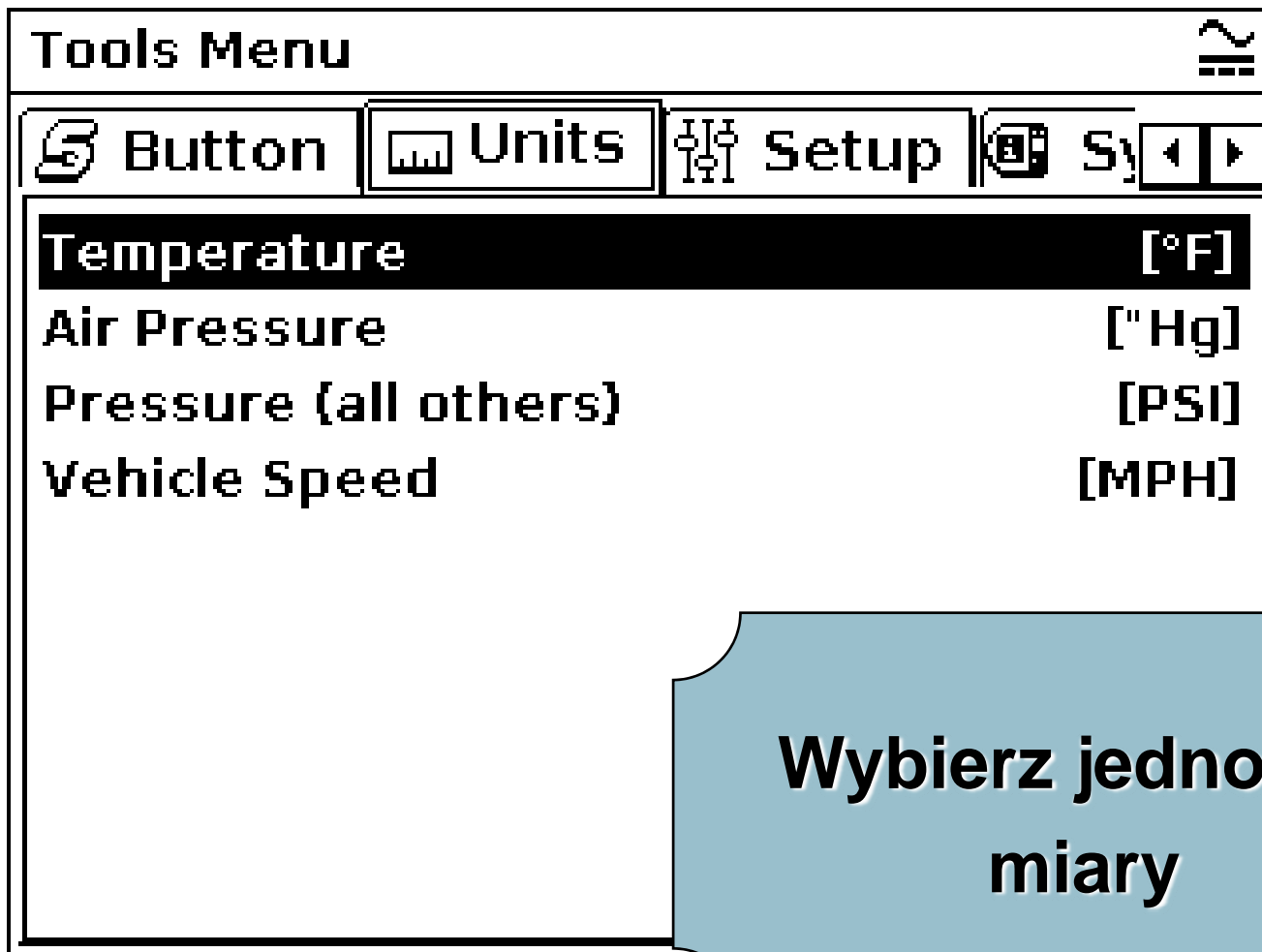

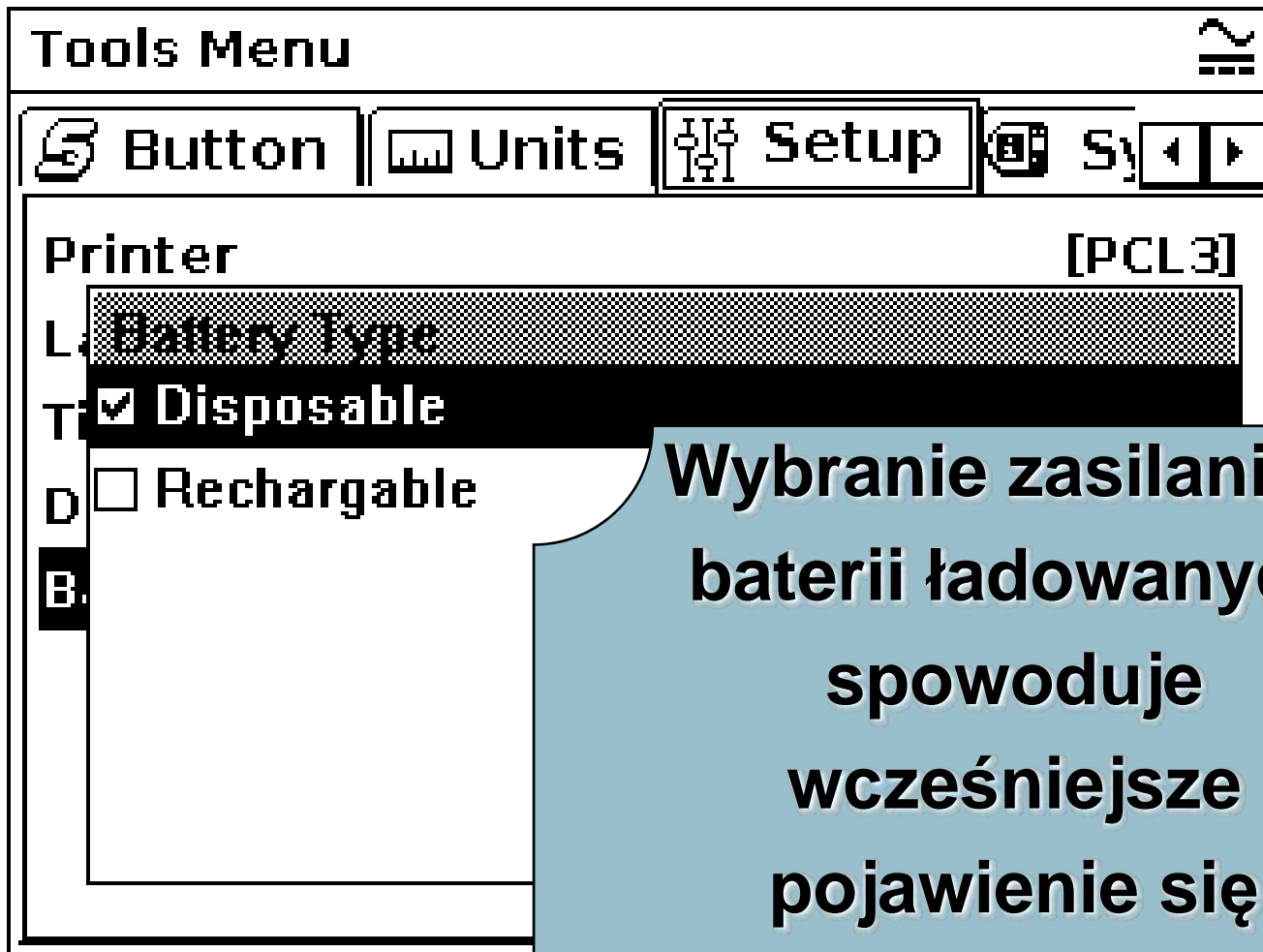
**Wybierz funkcję dla programowalnego przycisku „S”**





**Wybranie zasilania z baterii ładowanych spowoduje wcześniejsze pojawienie się komunikatu o niskim stanie naładowania**

**Tools Menu** 

 **Units** |  **Setup** |  **Sys** |  **PC-L**  

# ETHOS™

Copyright 2007 Snap-on Incorporated. All Rights Reserved.  
ETHOS™ is a trademark of Snap-on Incorporated.  
Patents US B15,442,170; AU 690,261; US 6,693,367 B1; Patents Pending.

**01/12/2007 08:05:52\***  
**Bundle 7.1 Versi**  
**Serial Number:**  
**0E35 0202 1B3**

**Zakładka Sys podaje  
informacje o wersji  
oprogramowania**

...S F-350 6.8L V10 SOHC EEC-V SEFI



Select System:

Engine

Transmission

**Antilock Brakes**

Airbag

Body Systems

Transfer Case

**Szeroki zakres  
możliwości  
diagnostycznych**

...RD CAR FOCUS 2.0L L4 EEC-V SEFI



Codes Menu:

**KOEO Self-Test**

KOER Self-Test

Memory Codes

Pending Codes

Clear Codes

Review Codes

Print Codes



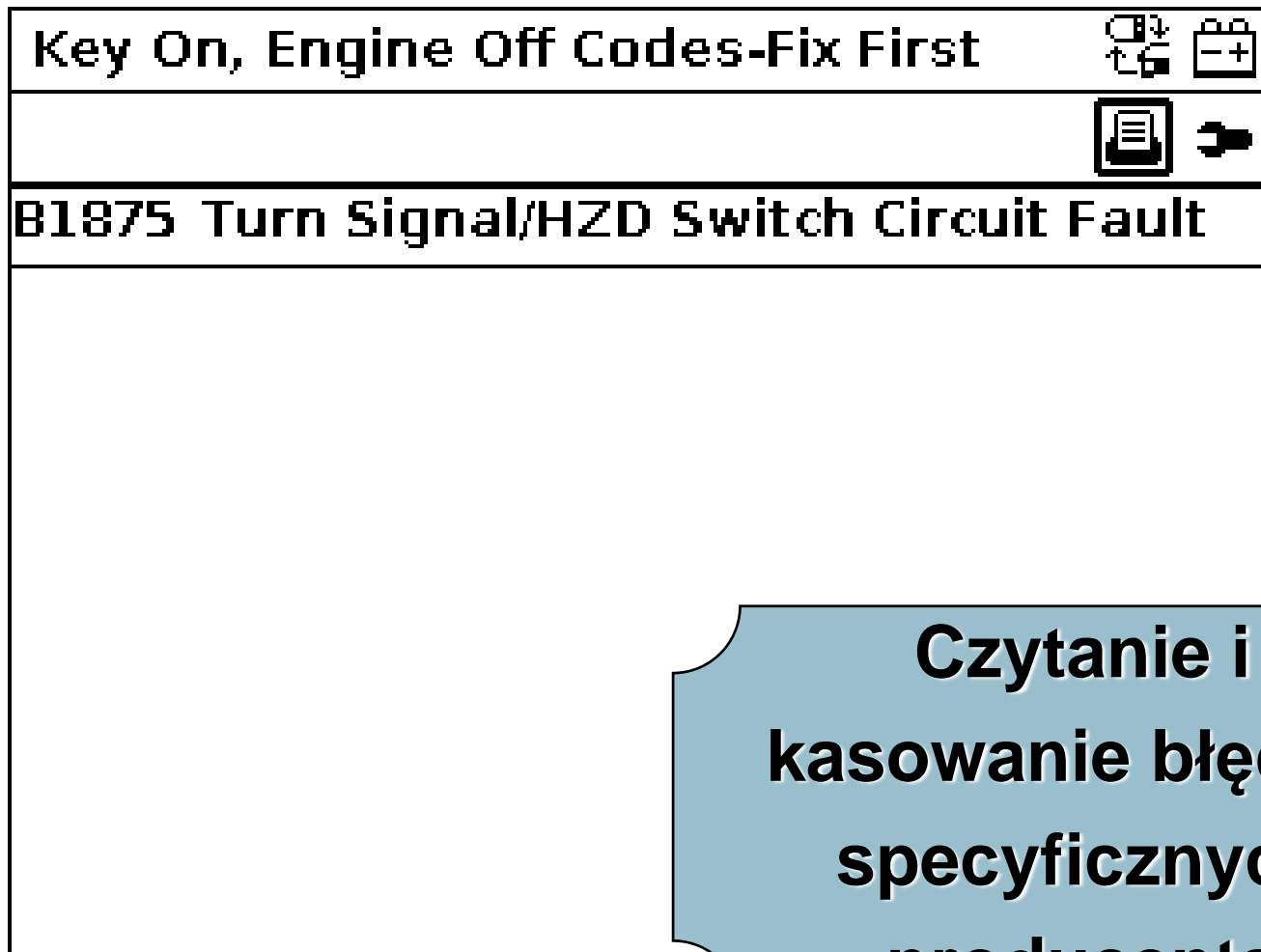



**Zaawansowany system  
odczytu i kasowania  
kodów błędów**











**Czytanie i  
kasowanie błędów  
specyficzných  
producenta**

History Codes	
26	Quad Driver Module (QDM) Failure
23	Manifold Air Temperature Too Low
36	Trans Shift Problem













**Lista kodów  
rozszerzona  
znacznie poza kody  
OBD-II**

RPM	
<div style="text-align: right;">       </div>	
<b>RPM</b>	<b>695</b>
VSS(MPH)	10
A/C CLUTCH	ON
A/C SW	ON
ALT CTRL	12.5V
ALTERNATOR(%)	
BARO(" Hg)	
BARO(V)	
BATT(V)	



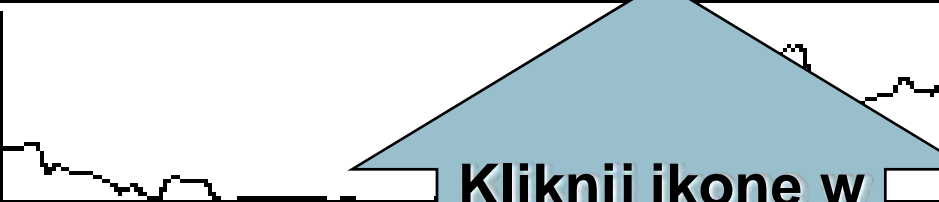



**Odczyt parametrów  
bieżących**

RPM		 
		     
<b>RPM</b>	<b>695</b>	
VSS(MPH)	10	
A/C CLUTCH	ON	
A/C SW	ON	
ALT CTRL	12.5V	
ALTERNATOR(%)	69	
BARO(" Hg)	28.9	
BARO(V)	2.81	
BATT(V)	14.2	

Kliknij ikonę  
w celu  
przełączenia  
między  
trybem  
odczytu i  
wykresu

RPM	
<div style="text-align: right;">   </div>	
     	
<b>RPM</b> 1748 626-2450	
<b>VSS(MPH)</b> 44 0-44	
<b>A/C CLUTCH</b> ON ON-ON	
<b>A/C SW</b> ON ON-ON	

**Kliknij ikonę w celu zatwierdzenia parametru pokazywanych w trybie graficznym**

<b>ECT(V)</b>		 	
		 	
<b>RPM</b>	1707 626-2450	<p><b>Wybrane parametru są pokazywane w górnej części ekranu</b></p>	
<b>ECT(°F)</b>	189 189-196		
<b>ECT(V)</b>	0.66 0.61-0.66	<p><b>Przewijaj w celu podglądu pozostałych parametrów</b></p>	
<b>EGR POS(V)</b>	1.35 1.33-3.85		

EGR POS(V)		
RPM	2097	<b>Locked PIDs Remain at Top</b>
ECT(°F)	189	
BATT(V)	14.2	<b>Scroll Unlocked PIDs</b>
BRAKE SW	OFF	
CLV(%)	73	
ECT(°F)	189	
ECT(V)	0.66	
<b>EGR POS(V)</b>	<b>2.05</b>	
ELD(A)	37.1	

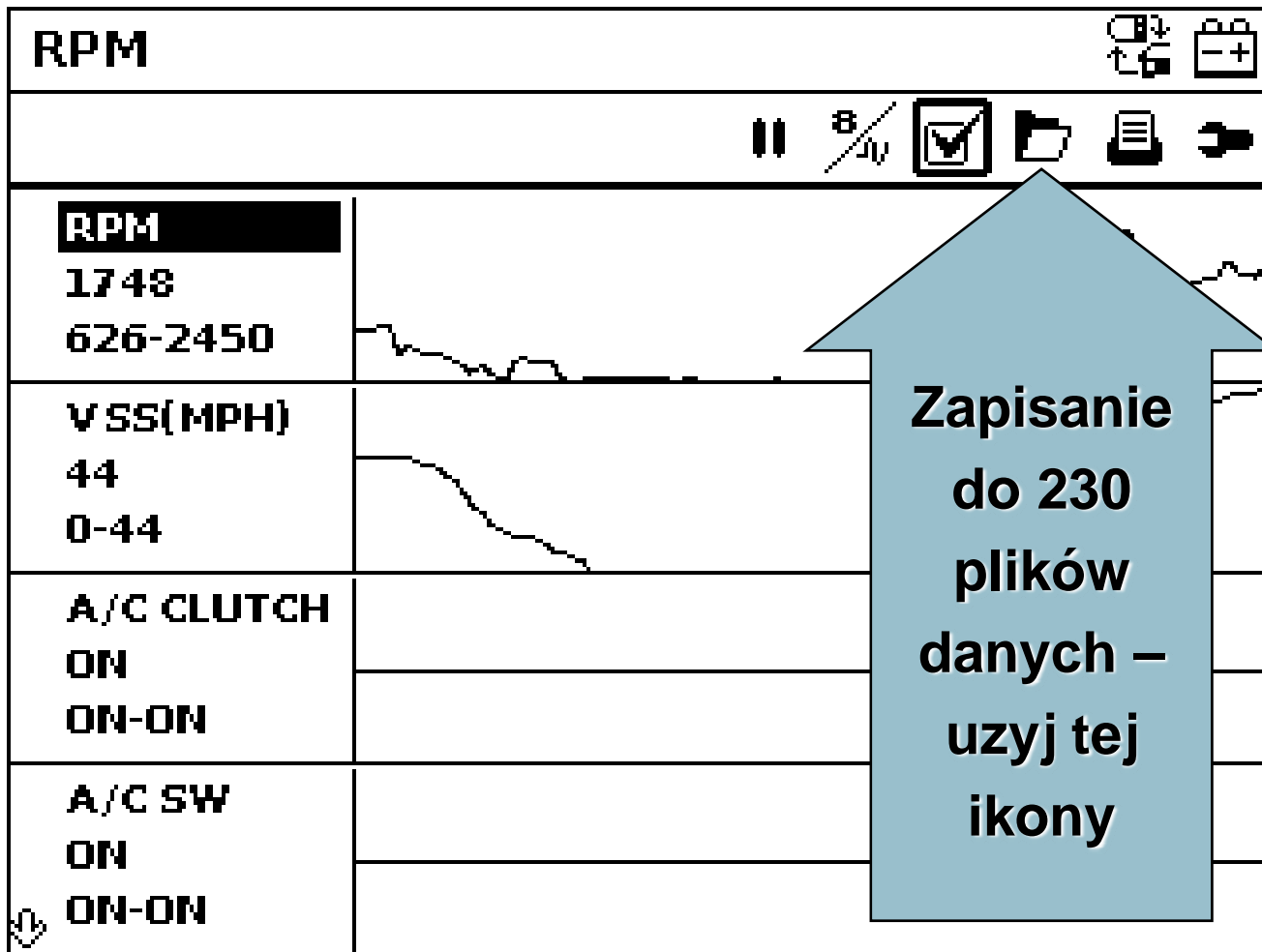

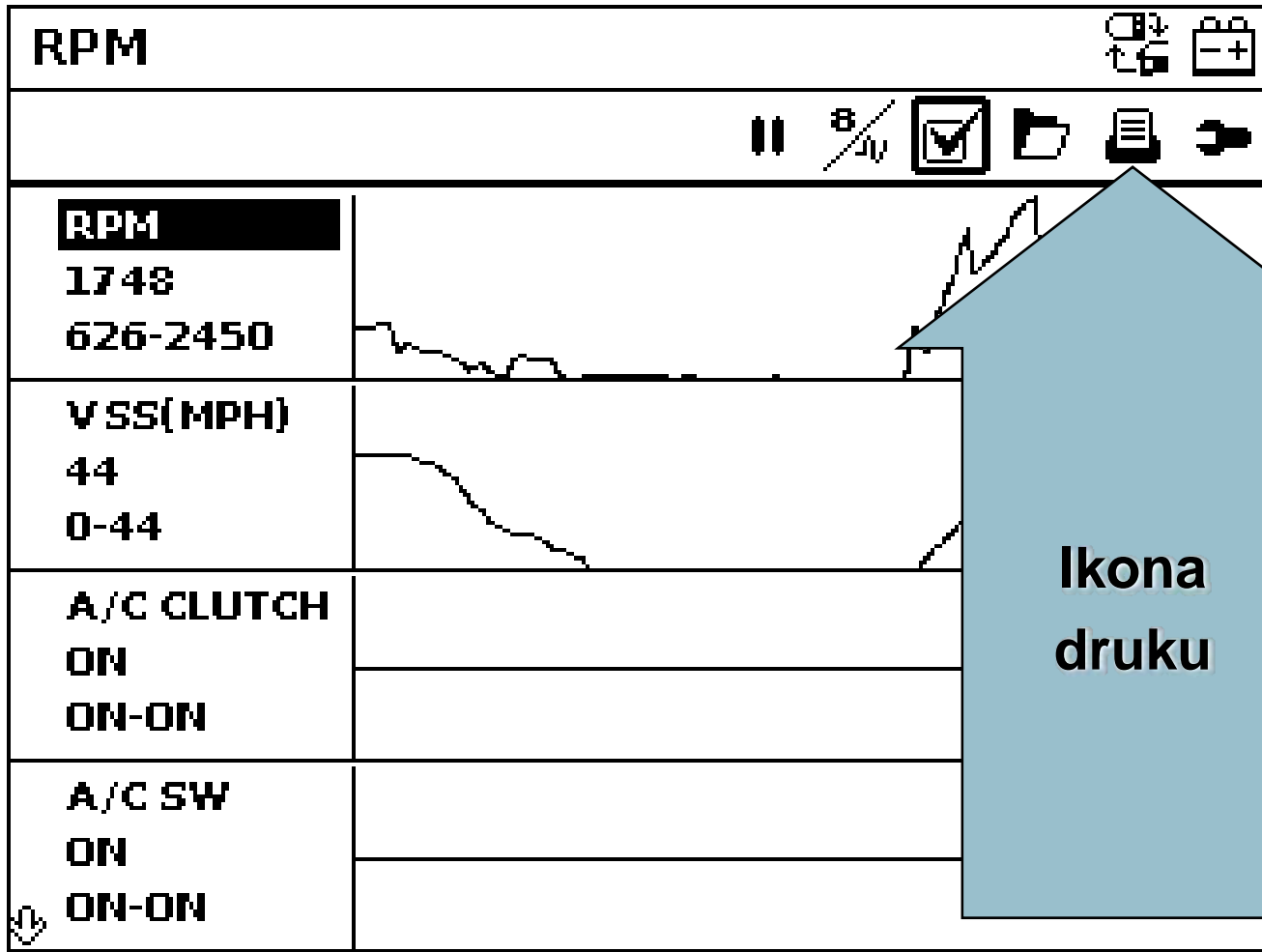

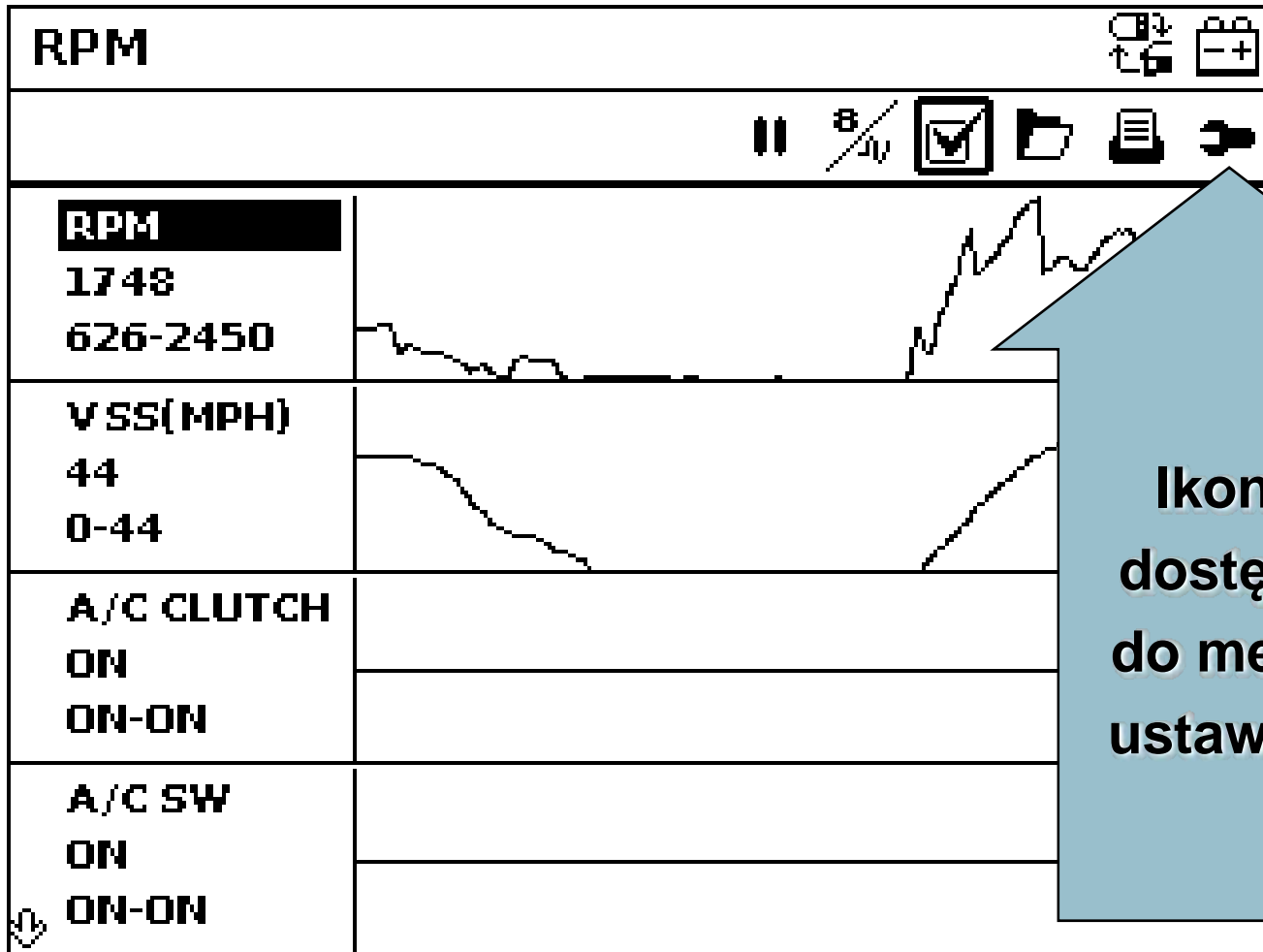

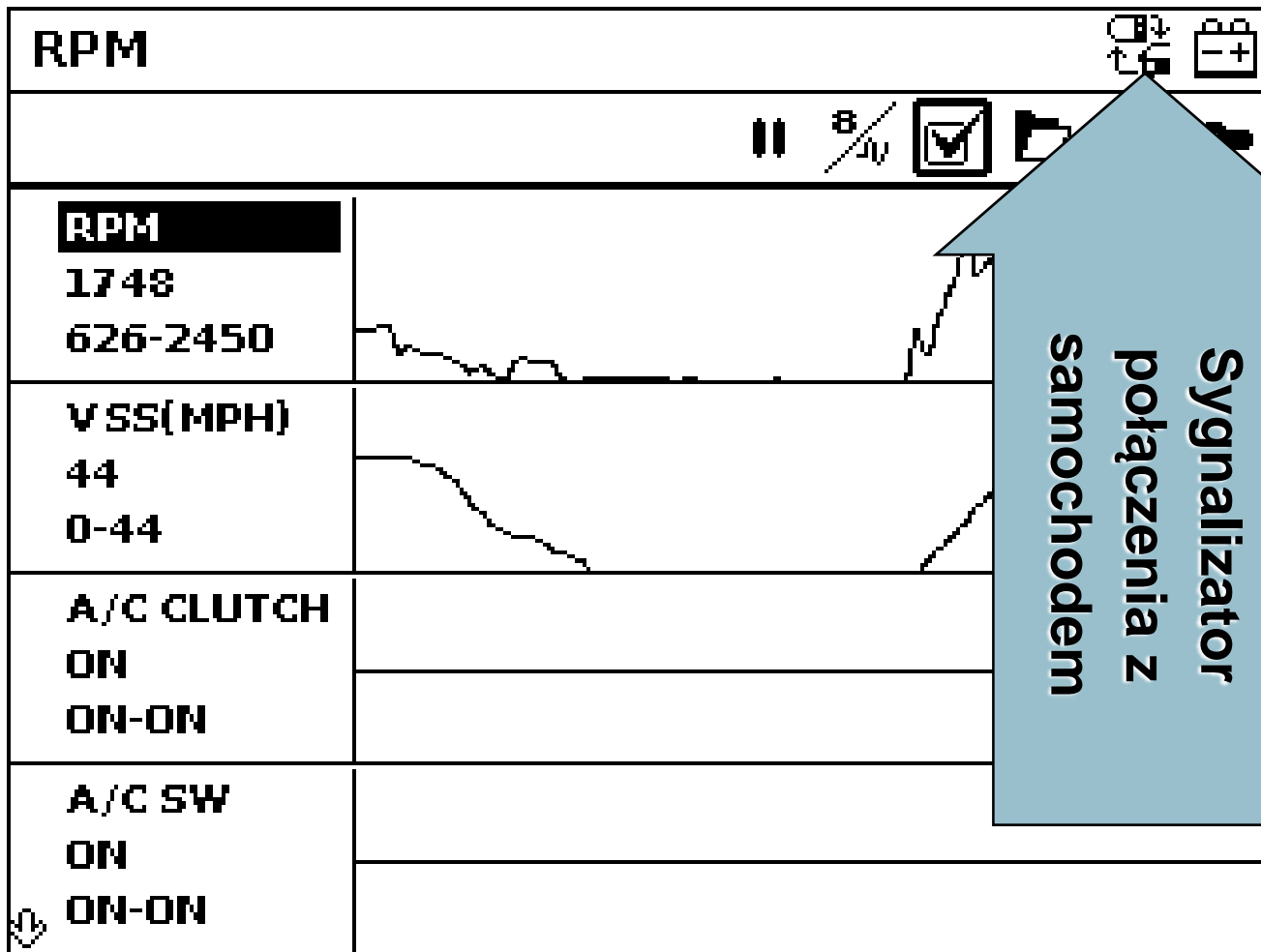

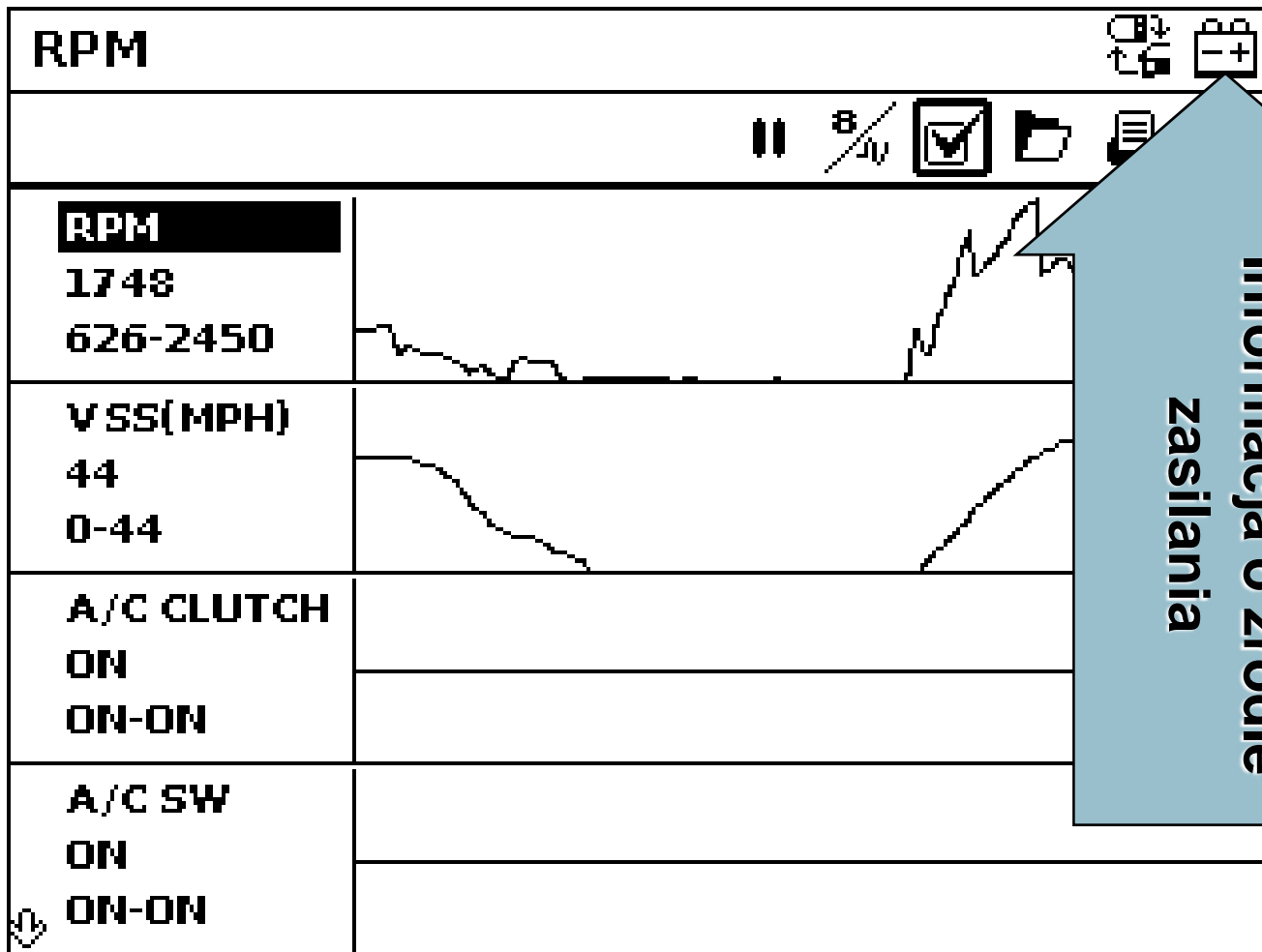

Informacia o zdrojle zasilania

**SOLUS™** > **ETHOS™**

- **Dodatkowe funkcje SOLUS**

- Testy funkcjonalne członów wykonawczych
  - Te testy pozwalają na dwustronna komunikację z ECU
  - Diagnoza i naprawa
- Duży ekran kolorowy



# ETHOS™



First  
Scanner  
Purchase



↑ Share of  
Diagnostic  
Work



Upgrade  
from  
OBD-II



Supplement  
High-End  
Tool



Priceless  
Shop  
Tool

# ETHOS™

